



## High Pressure Equipment

### Ultra High Pressure Valves, Fittings and Tubing 100,000 and 150,000 psi service

High Pressure Equipment Company has developed a line of Ultra High Pressure products to assure safe and easy plumbing for 100,000 psi and 150,000 psi. These needle valves, fittings, check valves, tubing and nipples are engineered to the highest standards of repeatable quality. The reliable performance of these products has made HiP one of the world's leading suppliers of elevated pressure components.

Ultra High Pressure components use a coned-and-threaded connection which accommodates the extreme conditions found in these applications. Ultra High Pressure valves are available in  $\frac{1}{4}$ " and  $\frac{3}{8}$ " O.D. tubing sizes and four patterns to satisfy widely varied requirements. A line of fittings is available to facilitate adapting to High Pressure systems.



### Index

Page

100,000 psi Valves . . . . .	.5.2
150,000 psi Valves . . . . .	.5.3
Fittings . . . . .	.5.4
Check Valves . . . . .	.5.4
Tubing . . . . .	.5.5
Coned and Threaded Nipples . . . . .	.5.5
Connection Details . . . . .	.5.A
	Appendix



## High Pressure Equipment

### Ultra High Pressure Valves 100,000 psi service

High Pressure (coned and threaded) type connections for  $\frac{1}{4}$ " O.D. by  $\frac{1}{16}$ " I.D. tubing.

**Non-rotating tip stems** insure long life on valve seats.

Heavy duty "rolled style" stem design is shown below.

**Glands and collars** for tubing are supplied with each valve unless otherwise requested (glands and collars are shown on page 5.A).

**Materials** include 316 stainless steel for valve bodies with tool steel lower section stems. Valve packing is teflon.

**Corresponding fittings** (elbows, tees, crosses, etc.) are shown on page 5.4.

**Replaceable Seat Valves** are available for  $\frac{1}{4}$ " O.D. tubing.

These valves feature the same body style and body dimensions as the two way angle valves (shown below).

To order add "R" to the corresponding two way valve catalog number (eg. 100-12XF4R).

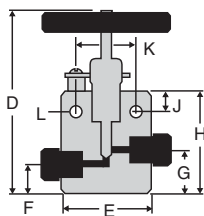
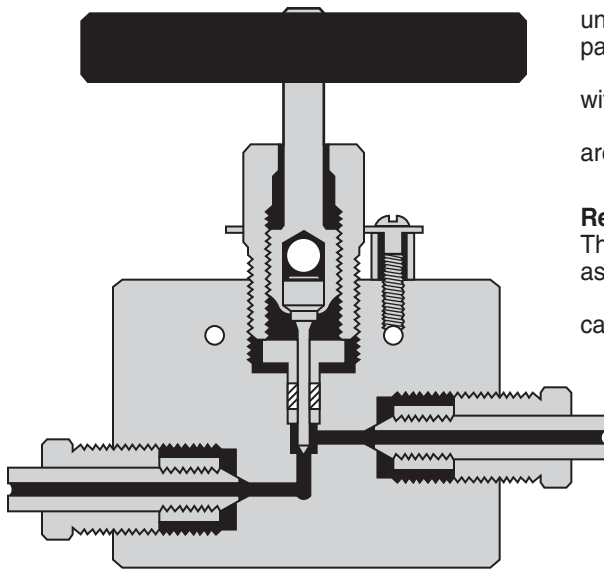

Two Way  
Straight

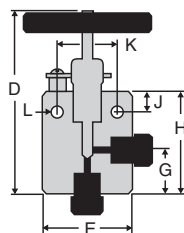

Two Way  
Angle

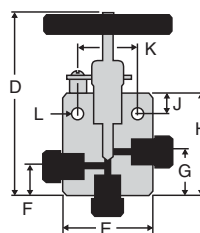

Three Way  
Two Inlets

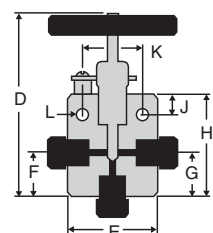

Three Way  
One Inlet

### Manual Shutoff Valves

Body Pattern	Tubing	Catalog No.	psi	Connection	Orifice	D	E	F	G	H	J	K	L	Thickness
2-Way Straight	$\frac{1}{4}$ " O.D.	100-11XF4	100,000	XF4	$\frac{1}{16}$ "	5"	$2\frac{5}{8}$ "	$\frac{3}{4}$ "	$1\frac{1}{16}$ "	$2\frac{1}{2}$ "	$\frac{1}{2}$ "	$1\frac{5}{8}$ "	$\frac{7}{32}$ "	$1\frac{1}{2}$ "
2-Way Angle	$\frac{1}{4}$ " O.D.	100-12XF4	100,000	XF4	$\frac{1}{16}$ "	$5\frac{1}{4}$ "	$2\frac{5}{8}$ "	—	$1\frac{5}{16}$ "	$2\frac{3}{4}$ "	$\frac{1}{2}$ "	$1\frac{5}{8}$ "	$\frac{7}{32}$ "	$1\frac{1}{2}$ "
3-Way/2 Inlets	$\frac{1}{4}$ " O.D.	100-13XF4	100,000	XF4	$\frac{1}{16}$ "	$5\frac{1}{2}$ "	$2\frac{5}{8}$ "	$1\frac{1}{4}$ "	$1\frac{9}{16}$ "	3"	$\frac{1}{2}$ "	$1\frac{5}{8}$ "	$\frac{7}{32}$ "	$1\frac{1}{2}$ "
3-Way/1 Inlet	$\frac{1}{4}$ " O.D.	100-14XF4	100,000	XF4	$\frac{1}{16}$ "	$5\frac{1}{4}$ "	$2\frac{5}{8}$ "	$1\frac{5}{16}$ "	$1\frac{5}{16}$ "	$2\frac{3}{4}$ "	$\frac{1}{2}$ "	$1\frac{5}{8}$ "	$\frac{7}{32}$ "	$1\frac{1}{2}$ "

## Ultra High Pressure Valves 150,000 psi service

**High Pressure (coned and threaded)** type connections for  $\frac{3}{8}$ " O.D. by  $\frac{1}{16}$ " I.D. tubing.

**Non-rotating tip stems** insure long life on valve seats.

Heavy duty "rolled style" stem design is shown below.

**Glands and collars** for tubing are supplied with each valve unless otherwise requested (glands and collars are shown on page 5.A).

**Materials** include 17-4 PH for valve bodies with tool steel lower section stems. Valve packing is teflon.

**Corresponding fittings** (elbows, tees, crosses, etc.) are shown on page 5.4.

**Replaceable Seat Valves** are available for  $\frac{3}{8}$ " O.D. tubing. These valves feature the same body style and dimensions as the two way valves (shown below).

To order add "R" to the corresponding two way valve catalog number (eg. 150-12XF6R).

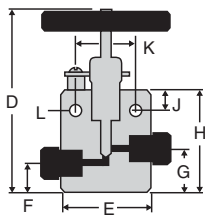
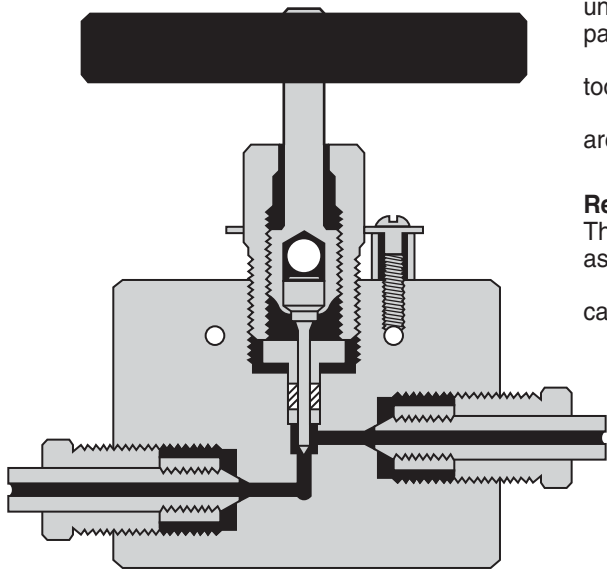

Two Way  
Straight

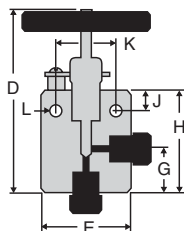

Two Way  
Angle

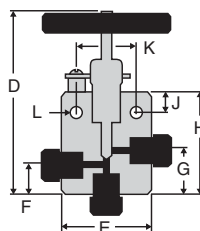

Three Way  
Two Inlets

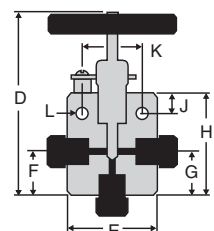

Three Way  
One Inlet

## Manual Shutoff Valves

Body Pattern	Tubing	Catalog No.	psi	Connection	Orifice	D	E	F	G	H	J	K	L	Thickness
2-Way Straight	$\frac{3}{8}$ " O.D.	150-11XF6	150,000	XF6	$\frac{1}{16}$ "	5"	$3\frac{1}{2}$ "	$\frac{7}{8}$ "	$1\frac{3}{16}$ "	$2\frac{5}{8}$ "	$\frac{1}{2}$ "	$1\frac{5}{8}$ "	$\frac{7}{32}$ "	$1\frac{1}{2}$ "
2-Way Angle	$\frac{3}{8}$ " O.D.	150-12XF6	150,000	XF6	$\frac{1}{16}$ "	$5\frac{7}{8}$ "	$3\frac{1}{2}$ "	—	$2\frac{1}{16}$ "	$3\frac{1}{2}$ "	$\frac{1}{2}$ "	$1\frac{5}{8}$ "	$\frac{7}{32}$ "	$1\frac{1}{2}$ "
3-Way/2 Inlets	$\frac{3}{8}$ " O.D.	150-13XF6	150,000	XF6	$\frac{1}{16}$ "	$5\frac{7}{8}$ "	$3\frac{1}{2}$ "	$1\frac{3}{4}$ "	$2\frac{1}{16}$ "	$3\frac{1}{2}$ "	$\frac{1}{2}$ "	$1\frac{5}{8}$ "	$\frac{7}{32}$ "	$1\frac{1}{2}$ "
3-Way/1 Inlet	$\frac{3}{8}$ " O.D.	150-14XF6	150,000	XF6	$\frac{1}{16}$ "	$5\frac{7}{8}$ "	$3\frac{1}{2}$ "	$2\frac{1}{16}$ "	$2\frac{1}{16}$ "	$3\frac{1}{2}$ "	$\frac{1}{2}$ "	$1\frac{5}{8}$ "	$\frac{7}{32}$ "	$1\frac{1}{2}$ "



## High Pressure Equipment

### Fittings/Check Valves

We have developed check valves, elbows, tees and crosses for both the 100,000 and 150,000 psi systems. \*Material is high tensile 316 stainless steel. Standard tubing glands and collars are furnished unless otherwise specified.

\* Note: Material for 150,000 psi check valve is 17-4 PH.

#### Ultra High Pressure Check Valves

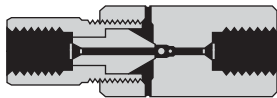

Catalog No.	psi	Connections	Length	Hex
100-41XF4	100,000	1/4" ULTRA PRESSURE	3 <sup>9</sup> / <sub>16</sub> "	1 1/2"
150-41XF6	150,000	3/8" ULTRA PRESSURE	4 1/2"	1 1/2"

#### Ultra High Pressure Elbows

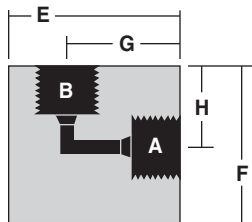

Catalog No.	Pressure Rating psi	Connections	A-B-C-D	E	F	G	H	Thickness
100-22XF4	100,000	1/4" O.D. TUBE	XF4	1 3/4"	1 3/4"	1 1/4"	1 1/4"	1"
150-22XF6	150,000	3/8" O.D. TUBE	XF6	2 5/8"	2 5/8"	1 3/4"	1 3/4"	1 1/2"

#### Ultra High Pressure Tees

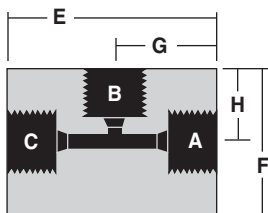

Catalog No.	Pressure Rating psi	Connections	A-B-C-D	E	F	G	H	Thickness
100-23XF4	100,000	1/4" O.D. TUBE	XF4	2 1/2"	1 3/4"	1 1/4"	1 1/4"	1"
150-23XF6	150,000	3/8" O.D. TUBE	XF6	3 1/2"	2 5/8"	1 3/4"	1 3/4"	1 1/2"

#### Ultra High Pressure Crosses

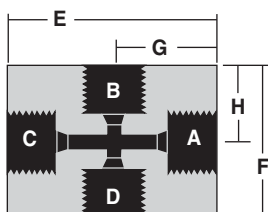

Catalog No.	Pressure Rating psi	Connections	A-B-C-D	E	F	G	H	Thickness
100-24XF4	100,000	1/4" O.D. TUBE	XF4	2 1/2"	2 1/2"	1 1/4"	1 1/4"	1"
150-24XF6	150,000	3/8" O.D. TUBE	XF6	3 1/2"	3 1/2"	1 3/4"	1 3/4"	1 1/2"

## Ultra High Pressure Tubing

Tubing is cold drawn, seamless, and is supplied in the  $\frac{1}{8}$  hard condition (not annealed). Tensile strength is approximately 40 percent higher than that of annealed tubing. All tubing is manufactured in strict accordance with High Pressure Equipment Company specifications to insure tolerances and bore quality. Tubing is stocked in lengths of 18 to 22 feet but may be ordered in shorter lengths with **no additional cutting charge**.



	Tubing Size	Working Pressure psi	Type of Connection Used	Material	Catalog Order Number
<b><math>\frac{1}{4}</math>"</b>	$\frac{1}{4}$ " O.D. x $\frac{1}{16}$ " I.D.	100,000	$\frac{1}{4}$ " ULTRA HIGH PRESSURE (XF4)	316 SS	100-9X4-316
				304 SS	100-9X4-304
<b><math>\frac{3}{8}</math>"</b>	$\frac{3}{8}$ " O.D. x $\frac{1}{16}$ " I.D.	150,000	$\frac{3}{8}$ " ULTRA HIGH PRESSURE (XF6)	304 SS	150-9X6

## Nipples

Nipples in lengths other than those shown are supplied upon request. Nipples are not furnished with collars and glands, unless specified at time of order.

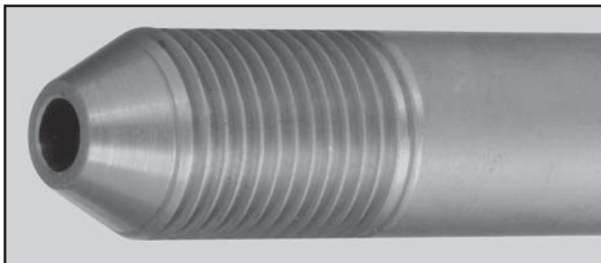

### Coned and Threaded Nipples

Length ↓	Tubing Size (O.D. x I.D.)		
	$\frac{1}{4}$ " O.D. x $\frac{1}{16}$ " I.D. (316 SS)	$\frac{1}{4}$ " O.D. x $\frac{1}{16}$ " I.D. (304 SS)	$\frac{3}{8}$ " O.D. x $\frac{1}{16}$ " I.D. (304 SS)
psi →	100,000 psi	100,000 psi	150,000 psi
$2\frac{3}{4}$ "	100-XM4-2.75	100-XM4-2.75	
4"			150-XM6-4
6"	100-XM4-6	100-XM4-6	150-XM6-6
8"	100-XM4-8	100-XM4-8	150-XM6-8
10"	100-XM4-10	100-XM4-10	150-XM6-10
12"	100-XM4-12	100-XM4-12	150-XM6-12



## High Pressure Equipment

### Ultra High Pressure Connections

**(Coned and Threaded)  
100,000 and 150,000 psi service**

The Ultra High Pressure tubing connection is available for  $\frac{1}{4}$ " and  $\frac{3}{8}$ " O.D. tubing. The tubing may be prepared with the use of tooling (see tooling section 9.0) or prepared at the factory to specified lengths. Additionally, standard length coned and threaded nipples are available from stock, see page 5.5.

This connection has become an industry standard for use at elevated pressures and temperatures in both liquid and gas applications. It may be disassembled and retightened indefinitely.

The threads of the gland are right-hand while the threads of the collar and tubing are left-hand to prevent rotation of the collar during assembly.

**Materials.** All of the components required for make-up of a Ultra High Pressure connection (glands, collars and plugs) are produced in Type 316 stainless steel.

**Necessary glands and collars** are provided with all valves and fittings (except nipples) unless otherwise requested (see chart on the right for size details and catalog numbers).

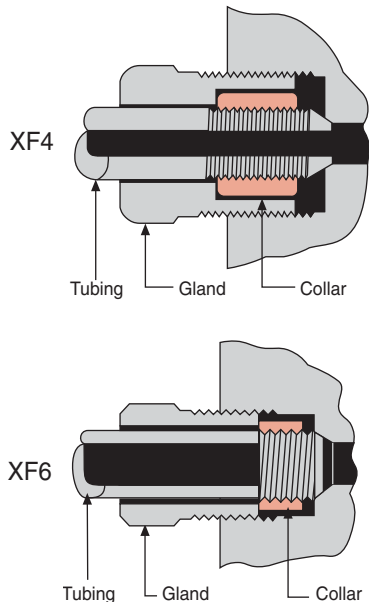

	100,000 psi <b>XF4</b> 1/4" O.D. Tubing	150,000 psi <b>XF6</b> 3/8" O.D. Tubing
<b>Female Opening Detail</b>		
<b>Gland</b>		
<b>Collar</b>		
<b>Plug</b>		
<b>Tube End Prep</b>		